

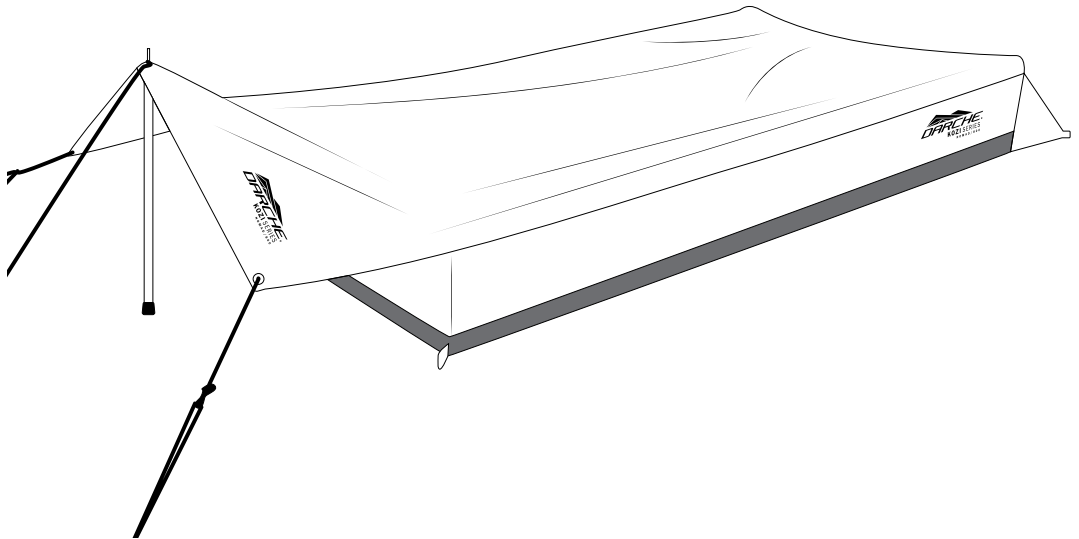

DARCHE[®]
KOZI SERIES

N O M A D S W A G

INSTRUCTION MANUAL



KSS1011
KSS1012

I N S T R U C T I O N M A N U A L

CONTENTS

- 1 x Nomad swag
- 1 x Adjustable head pole
- 1 x 50mm high-density foam mattress
- 8 x Pegs
- 4 x Guy ropes

PLEASE NOTE

Prior to first use of the Nomad swag, it is important to remove the mattress from its compression sleeve and allow it to expand.

Seasoning the swag is not essential but is recommended. For full instructions on seasoning your DARCHE swag, see How to Season Your Swag (page 7).

SETTING UP YOUR SWAG

Step 1

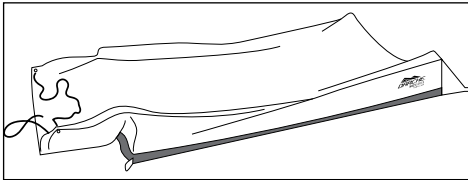

Unroll the swag onto a flat, well-drained area free of sharp objects that may penetrate the swags PVC floor. Stretch the four corners of the swag outwards then peg out the corner base points.

Step 2

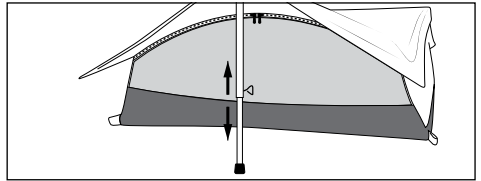
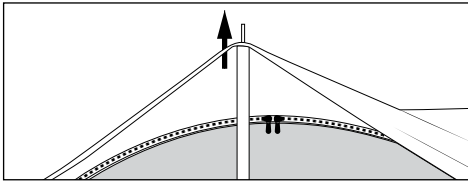

Position the adjustable head pole under the middle eyelet at the head of the swag then extend the pole.

Step 3

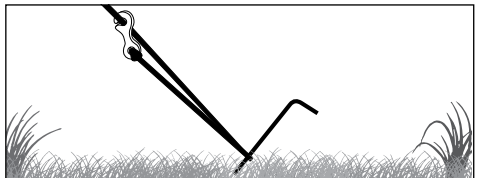
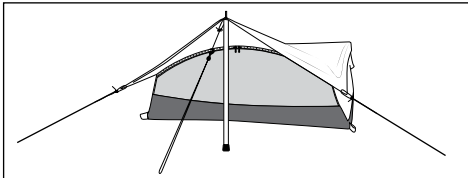

Extend the 4x guy ropes. Loop each guy rope around the steel peg to secure the swag to the ground. Tension the guy ropes. Your Nomad swag is now ready to use.

INSTRUCTION MANUAL

PACK DOWN

1. Partially close all the zips and door covers. Leaving them slightly open will allow for the air to escape while rolling up the swag. Remove the pegs and roll up the guy ropes.
2. Release the adjustable head pole and remove from the middle eyelet.
3. While the swag is laid out flat, bring any over overhanging canvas and ropes into the centre of the swag. Beginning from the foot end, start rolling the swag as tightly as possible in an attempt to expel as much air as possible to achieve a compact roll. Tip: Using your knees, or two people while rolling, will assist in getting the swag as compact as possible. Just before completing the rolling process, place the disassembled pole within the swag and continue the rolling process to the end.

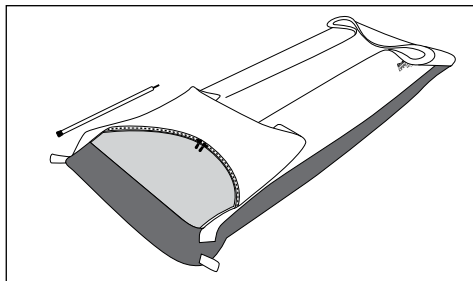

4. Bring the two compression straps together and loop through the doubled-rings, do not over-tighten the straps.

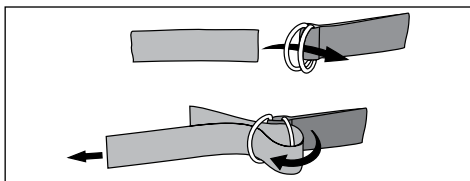
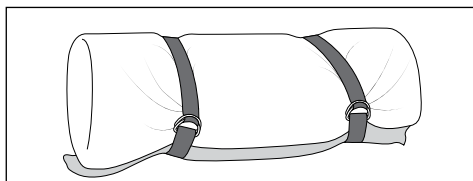

NOTE

Allow a wet or damp swag to dry thoroughly before pack down. If this is not possible, unroll swag as soon as possible. Allow to fully dry out before re-packing and storing

SPARE PARTS LIST

For a full list of Spare Parts available refer to DARCHE.COM.AU

HOW TO SEASON YOUR DARCHE SWAG

The best way to season your swag is to set up outdoors and completely soak the exterior material of the swag with a hose. Allow the swag to dry completely. Repeat this process 2-3 times. Seasoning the swag will allow the canvas material to swell and will help to fill any stitching holes, providing an additional level of weather protection. Ensure the swag is completely dry before packing away.

CARE & STORAGE INSTRUCTIONS

1. Remove dirt with a soft brush and cold water after use.
2. Do not clean with soap, detergent, petrol, oil or solvents.
3. Ensure swag is completely dry before storing.
4. Do not store directly on concrete floors. A dry shelf in your shed or a cupboard is a perfect spot for your swag when not in use.
5. If spot mould is visible, brush it off with a stiff bristle nylon brush and vacuum the area to get rid of any residual spores.
6. Leaving your swag rolled too tightly for long periods of time may result in the mattress taking a while to bounce back. If it's been a while since your last adventure, open your swag a few days before you leave and allow the mattress to expand. Re-pack your swag and have a great weekend.

MOISTURE/CONDENSATION

Condensation is a natural occurrence in confined areas like swags/tents due to the body releasing more moisture than the canvas can dispose in cold weather. To minimise the chance of condensation, we recommend slightly opening the window to enable airflow on cold nights.

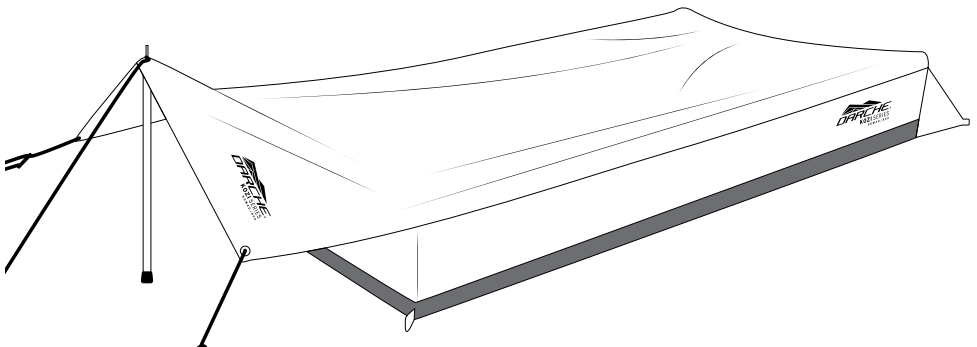

I N S T R U C T I O N M A N U A L

NOTES:

NOTES:

I N S T R U C T I O N M A N U A L

Designed and tested in Australia for Australian conditions.

A brand by Charles Parsons.

Telephone 1300 367 695 | Email: info@DARCHE.com.au

75 Heyington Avenue, Thomastown VIC 3074, Australia.

DARCHE: LEADERS IN OUTDOOR DESIGN. PROUDLY AUSTRALIAN.

Due to our policy of continual product development,
the specifications, colours and features may vary.

V1-JULY 2022



D A R C H E . C O M . A U