



ADVANCED MANUAL

UHF CB TRANSCEIVER
IC-410PRO

INTRODUCTION

1 ACCESSORIES AND INSTALLATION

2 BASIC OPERATION

3 SET MODE

4 REPEATER OPERATION

5 SCAN

6 TONE SQUELCH AND POCKET BEEP

7 SELCALL (Selective Calling)

8 OTHER FUNCTIONS

9 SPECIFICATIONS

INDEX

INTRODUCTION

IMPORTANT

READ ALL INSTRUCTIONS carefully before using the IC-410PRO UHF CB TRANSCEIVER.

KEEP THIS ADVANCED MANUAL, as it contains important operating information that may be useful in the future.

The **BASIC MANUAL** is supplied with the transceiver.

NOTE

This ADVANCED MANUAL is described, based on the IC-410PRO factory defaults. However, the setting values or options on your transceiver may differ from the descriptions in this manual, depending on the presetting by your dealer.

Ask your authorized Icom dealer or transceiver administrator for details.

Section 1

ACCESSORIES AND INSTALLATION

Supplied accessories.....	1-2
Rear panel connection.....	1-3
Mounting the transceiver.....	1-3

Supplied accessories

Microphone

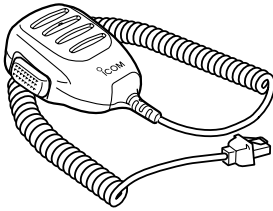

Microphone hanger and screw set

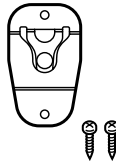

Microphone hanger cable



DC power cable

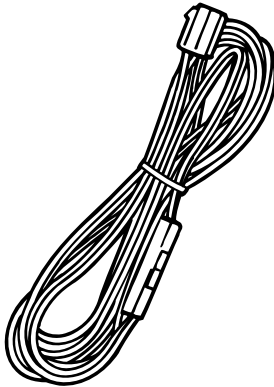

Function name stickers*

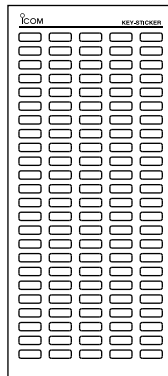

Mounting bracket

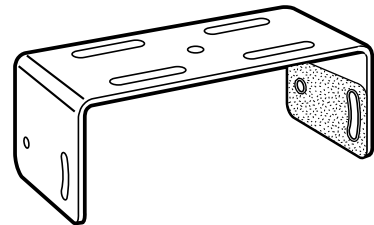

Flat washers



Nuts



Mounting screws

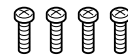

Spring washers



Bracket bolts



Self-tapping screws

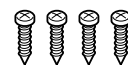

* Used for labelling the programmable function keys according to their assigned functions.

Rear panel connection

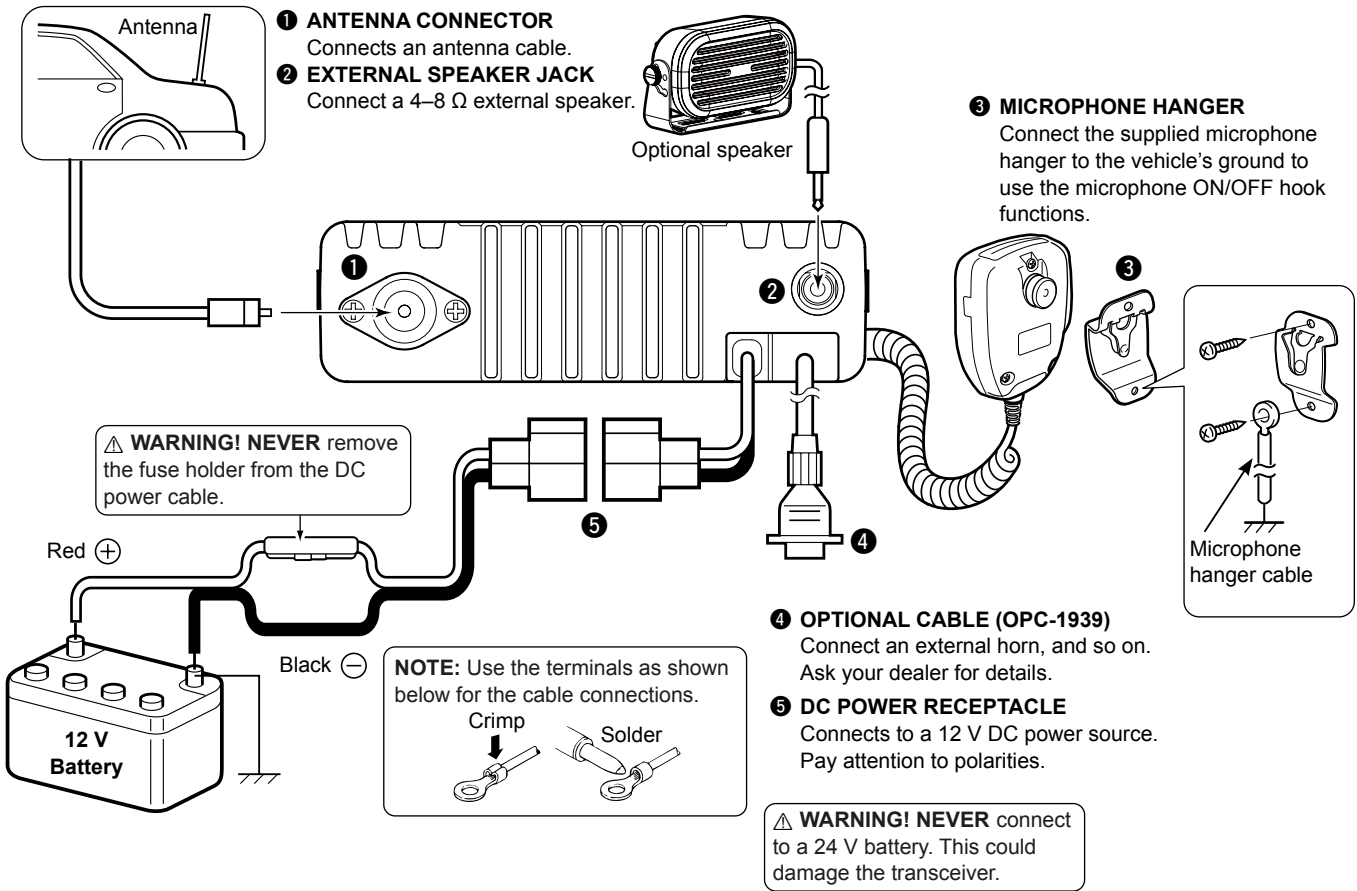

Mounting the transceiver

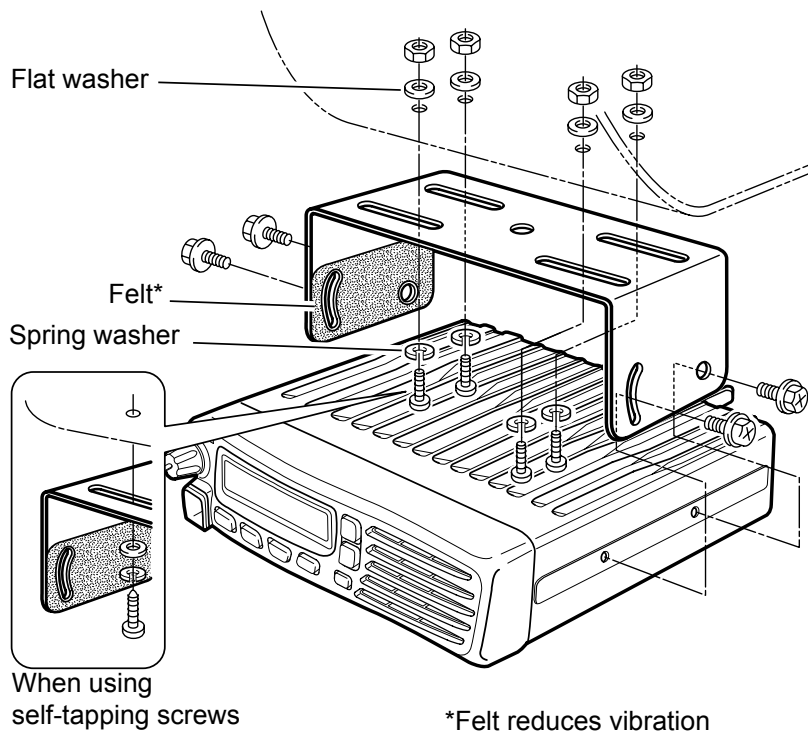

Section 2

BASIC OPERATION

Power ON password	2-2
Keylock	2-2
Channel selection	2-2
Zone selection	2-2
Priority channel	2-3
◇ Setting the Priority channel.....	2-3
◇ Selecting the Priority channel	2-3
◇ Cancelling the Priority channel	2-3
Monitor	2-3
Squelch	2-3

Power ON password

If the transceiver is set with a power ON password, enter the password when turning ON the transceiver. To enter the password, see the illustration below.



KEY	MONI	SCAN	DUP	FUNC	V
NUMBER	0 5	1 6	2 7	3 8	4 9

The password is a 4 digit code (example: 1234).

- ➔ Push the corresponding keys to enter your password.
 - Note that each key represents two digits. That means, “3764” and “8769” are entered in exactly the same way (requires no multiple or extended pushing.)
 - The entered password will not be displayed.
 - If “PASSWORD” does not disappear after entering, the entered password is incorrect. Turn OFF the transceiver, and then try again.

Keylock

Hold down for 2 seconds to electronically lock all keys except [DUP], [FUNC], and [MONI] to prevent accidental channel changing and function access.

To lock the keys:

- ➔ Hold down [DUP] for 2 seconds.

To unlock the keys:

- ➔ Hold down [DUP] for 2 seconds again.

◆ Non-locked keys

Even when the Keylock function is ON, you can use the following keys for certain conditions.

- [PTT]:** You can hold down to transmit, and release to receive.
- [DUP] (Normal mode):** You can hold down for 2 seconds to unlock the keys.
- [FUNC] (Normal mode):** You can push to change between Normal mode and Function mode.
- [MONI] (Normal mode):** You can push to turn the Monitor (open squelch) function ON or OFF.

Channel selection

There are 80 channels on the UHF CB and you have access to the designated repeater channels. You can select between them to communicate with the intended person(s). The IC-410PRO is also capable of storing a combination of up to 32 receive only and private channels, using the optional CS-410PRO CLONING SOFTWARE.

Push [UP]/[DOWN] to select the channels.

Zone selection

(Selectable only when more than 1 zones are set, using the optional CS-410PRO CLONING SOFTWARE)

A zone is a group of private channels, mainly used for commercial applications. It allows only certain groups or business departments to communicate within the allocated zone.

- 1) Turn ON the Function mode.
 - ➔ Push [FUNC].
 - “F” is displayed.
- 2) Enter the Zone Selection mode.
 - ➔ Hold down [FUNC] for 2 seconds.
- 3) Select the desired zone.
 - ➔ Push [UP]/[DOWN].
- 4) Return to the Standby mode.
 - ➔ Push [FUNC].

NOTE:

- The transceiver remains in the selected mode when turned OFF and then ON again.
- CB-05, CB-R05 and CB-35 channels are for emergency use, and are required to be left open for only emergency use. CB-22 and CB-23 are used for only receiving.

Priority channel

The Priority channel enables you to have quick access to a specific channel. Only one channel can be set as the Priority channel. "P" is displayed when the Priority channel is set.

◇ Setting the Priority channel

- 1) Select a desired channel.
 - Push [UP]/[DOWN].
- 2) Turn ON the Function mode.
 - Push [FUNC].
 - "F" is displayed.
- 3) Set the selected channel as the Priority channel.
 - Hold down [DUP] for 2 seconds.
 - "P" is displayed.

◇ Selecting the Priority channel

- 1) Turn ON the Function mode.
 - Push [FUNC].
 - "F" is displayed.
- 2) Select the Priority channel.
 - Push [DUP].
 - "N/A" is displayed when no Priority channel is set.

◇ Cancelling the Priority channel

- 1) Turn ON the Function mode.
 - Push [FUNC].
 - "F" is displayed.
- 2) Select the Priority channel.
 - Push [DUP].
- 3) Turn ON the Function mode.
 - Push [FUNC].
 - "F" is displayed.
- 4) Cancelling the Priority channel.
 - Hold down [DUP] for 2 seconds.
 - "P" disappears.

Monitor

The Monitor function opens the any squelch, enabling you to receive weak signals. This allows quick access to the open squelch setting.

Push [MONI] to turn the Monitor function ON or OFF.

Squelch

In order to quietly receive signals, set the squelch level to suit your environment. This eliminates background noise when there are no signals present. A higher level is better for inner cities or noisy areas, and a lower level is more beneficial in quiet, rural and country areas.

Setting the squelch level:

- 1) Enter the Set mode.
 - Hold down [FUNC] for 2 seconds.
- 2) Select the "SQL" menu.
 - Push [FUNC] until the "SQL" menu is displayed.
- 3) Set the squelch level to between 0 and 9.
 - Push [UP]/[DOWN].
- 4) Exit the Set mode.
 - Hold down [FUNC] for 2 seconds.

Set mode items	3-2
◇ Set mode sequence	3-2
◇ Squelch Level "SQL"	3-3
◇ Scan mode "SCAN-M"	3-3
◇ CTCSS/DTCS	3-3
◇ Backlight "LIGT"	3-3
◇ Beep "BEEP"	3-3
◇ Beep Level "BEPV"	3-3
◇ RF Power "RFPOW"	3-3
◇ Quiet mode "QUIET"	3-4
◇ Lockout "LOCK-O"	3-4
◇ Roger beep "RGR-B"	3-4
◇ Battery Voltage "BATT"	3-4
◇ Auto Power OFF "AP-OFF"	3-4
◇ Signal Monitor "SMON"	3-4
◇ Horn "HORN"	3-4
◇ RX VFO "RX VFO"	3-4
◇ Scan Stop Timer "S-TIME"	3-4
◇ Scan Restart "SCAN-R"	3-4
◇ Mic Gain "MIC"	3-5
◇ Lone Worker "LONE"	3-5
◇ AF Minimum Level "AFMIN"	3-5
◇ Own ID	3-5

Set mode items

◇ Set mode sequence

The table below describes the sequence of the items in the Set mode.

• The sequence is as shown below when you push [FUNC] in the Set mode.

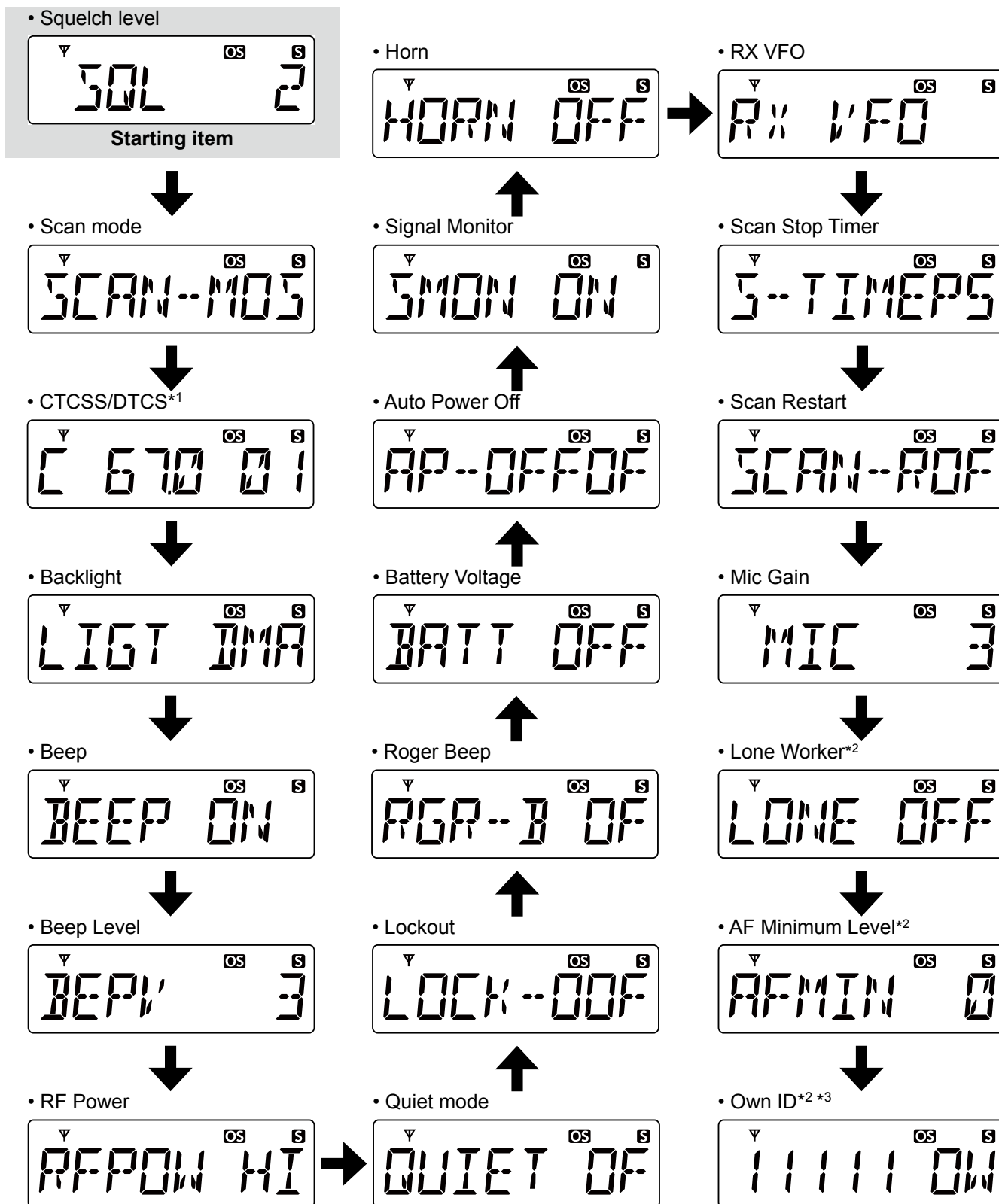

*1 Selected CTCSS or DTCS code is displayed.

*2 May not be displayed, depending on the transceiver's setting.

*3 5 digit Own ID is displayed.

Set mode items (Continued)

◇ **Squelch Level “SQL”**

The Squelch circuit eliminates background noise when no signals are present. Set the level to where the noise just disappears, for proper operation. A higher level is better for inner cities or noisy areas, and a lower level is more beneficial in quiet, rural or country areas. (0 = lowest, 9 = highest)



Squelch Level 2 (default)



Squelch Level 0

◇ **Scan mode “SCAN-M”**

Select the desired scan mode. See page 5-2 for details.

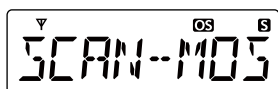

Open scan (default)

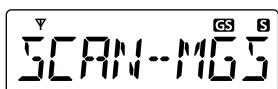

Group scan

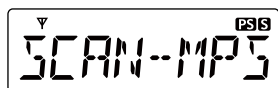

Priority scan

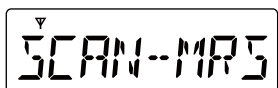

Repeater scan

◇ **CTCSS/DTCS**

Select the desired CTCSS tone frequency or DTCS code. You can change between CTCSS and DTCS setting modes by pushing [MONI]. See page 6-2 for more information about CTCSS and DTCS.



CTCSS Tone Frequency Setting mode (default)



DTCS Code Setting mode

◇ **Backlight “LIGT”**

The transceiver features a backlit LCD display for use in low-light conditions. You can select the backlight mode in the Set mode.

ON: Backlight is continuously ON.

DIM: The backlight continuously lights dimly.

DMA: When a signal activates the dimmer pin on the connected OPC-1939 ACC CABLE, the backlight lights dimly. When no signal is applied to the pin, the backlight is turned ON.

AU2: The backlight automatically turns ON for 5 seconds when changing the contents displayed on the LCD.

AUT: Lights for 5 seconds when you transmit or receive a Selcall signal, or when you push any key except [PTT].

OFF: No backlight.

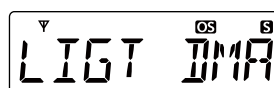

Backlight Auto (default)

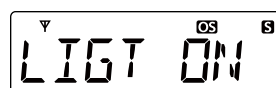

Backlight ON

◇ **Beep “BEEP”**

The confirmation beep is set to ON as the default. You can turn OFF the beep for silent operation in the Set mode.

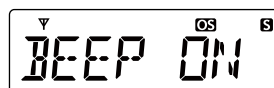

Beep ON (default)

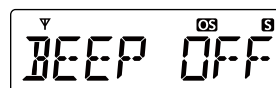

Beep OFF

◇ **Beep Level “BEPV”**

You can set the volume level for the key beeps to between 1 (soft) and 5 (loud).

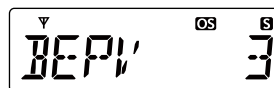

Beep level 3 (default)

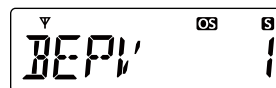

Beep level 1

◇ **RF Power “RFPOW”**

Set the RF power to High or Low.

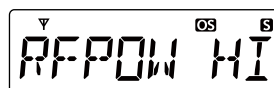

RF Power High (default)

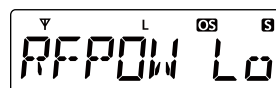

RF Power Low

Set mode items (Continued)

◇ **Quiet mode “QUIET”**

Turn On or OFF the Quiet mode for Selcall. See page 7-4 for details.



Quiet mode OFF (default)

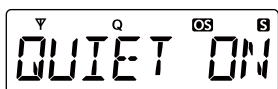

Quiet mode ON

◇ **Lockout “LOCK-O”**

Select the transmission Lockout function mode which temporarily inhibits transmission.

- RP (Repeater Lockout): Locks out a repeater.
- BU (Busy Lockout): Locks out a busy channel.
- OF (OFF): Turns OFF the function.

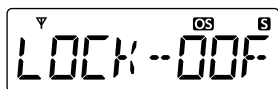

Lockout OFF (default)

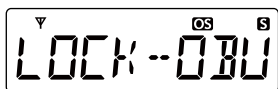

Busy lockout

◇ **Roger beep “RGR-B”**

You can turn ON the Roger Beep function to beep to indicate that the transmission has ended.

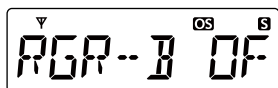

Roger Beep OFF (default)

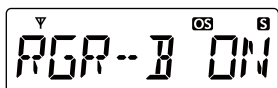

Roger Beep ON

◇ **Battery Voltage “BATT”**

You can set to display the Battery Voltage for 2 seconds, when you turn ON the transceiver.



Battery Voltage display OFF (default)



Battery Voltage display ON

◇ **Auto Power OFF “AP-OFF”**

You can set the transceiver to automatically turn OFF after the set period without any key operation. You can set it to between 0.5 and 4.0 hours (0.5 hour steps) or 8.0 hours.

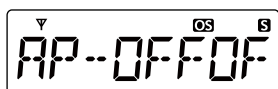

Auto Power OFF is OFF (default)

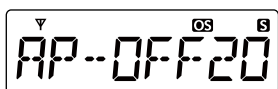

2 hour setting

◇ **Signal Monitor “SMON”**

You can select whether or not to sound a beep when you transmit a Selcall code or DTMF code signal.

- ON: A beep sounds.
- OFF: No beep sounds.

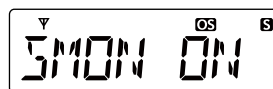

Signal Monitor ON (default)

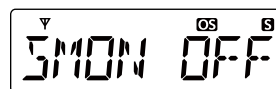

Signal Monitor OFF

◇ **Horn “HORN”**

Select whether or not to activate the HORN terminal when a call is received. This function is useful when a user is away from the transceiver.

*An external horn and an optional OPC-1939 ACC CABLE is required. Ask your dealer for details.

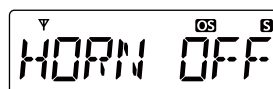

Horn is OFF (default)

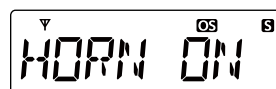

Horn is ON

◇ **RX VFO “RX VFO”**

Edit the RX channel frequency. See page 8-3 for details.

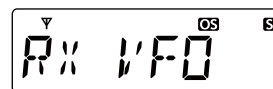

◇ **Scan Stop Timer “S-TIME”**

You can set the Scan Stop Timer to pause (P5) or timer scan (5/10/15). When a signal disappears, the scan resumes after the set period of time.

5/10/15: Scan pauses for 5, 10 or 15 seconds when a signal is detected, then resumes.

- P5: Scan pauses until the signal disappears, and then resumes after 5 seconds (Recommended setting).



Scan Stop Timer P5 (default)



10 second setting

◇ **Scan Restart “SCAN-R”**

This function restarts the scan 10 seconds after you stop transmitting. You can turn the function ON or OFF.

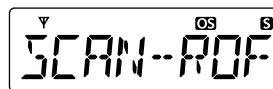

Scan Restart OFF (default)

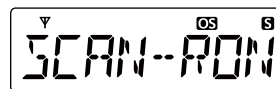

Scan Restart ON

Set mode items (Continued)

◇ **Mic Gain “MIC”**

You can adjust the microphone sensitivity to between 1 (minimum sensitivity) and 5 (maximum sensitivity). With a higher sensitivity, the microphone picks up softer voices, though it may pick up more ambient noise.



Mic Gain sensitivity 3 (default)



Mic Gain sensitivity 1

◇ **Lone Worker “LONE”**

(May not be displayed, depending on the transceiver’s setting.)

Turn the Lone Worker function ON or OFF. If no operation occurs during the set period, the Lone Worker function automatically puts the transceiver into the Emergency mode.

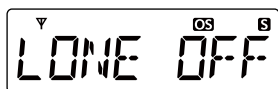

Lone Worker OFF (default)

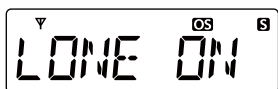

Lone Worker ON

◇ **AF Minimum Level “AFMIN”**

(May not be displayed, depending on the transceiver’s setting.)

Set the minimum audio output level to Between 0 and 255. This function determines the minimum audio output level to let the audio level become lower than the set level.



AF Minimum Level 0 (default)



AF Minimum Level 255

◇ **Own ID**

(You can only set this item after enabling the function using the optional CS-410PRO CLONING SOFTWARE.) This function enables you to allocate your Own ID which identifies you as a target for Selcall operation and allows tracking of the origin of transmissions.

1) Enter the editing mode when your Own ID is displayed.

➔ Hold down [MONI] for 2 seconds.

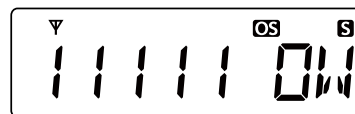

2) Select the desired number for the blinking digit.

➔ Push [UP]/[DOWN].

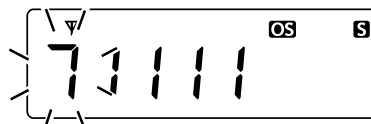

3) Set the blinking digit and go to the next digit.

➔ Push [MONI].



4) Repeat steps 2) and 3) until all 5 digits are set, and then push [MONI] again to save your Own ID.



Section 4 REPEATER OPERATION

Repeater operation.....4-2

Repeater operation

Repeaters extend the operational range of the transceiver by retransmitting the signals it receives. Repeaters are usually located on the top of a building or a mountain, as the elevation increases their effectiveness, allowing the user to transmit and receive over greater distances. In Simplex operation, transceivers transmit and receive on the same frequency. In Duplex operation (using a repeater) transceivers transmit and receive on different frequencies. It automatically does this when one of the repeater channels is selected.

Accessing a repeater:

To use a repeater, you need to select a repeater channel

(Repeater CH 1 to 8, and 41 to 48).

You can search for any accessible repeaters in your local area by using the Repeater scan. (p. 5-2, 5-3)

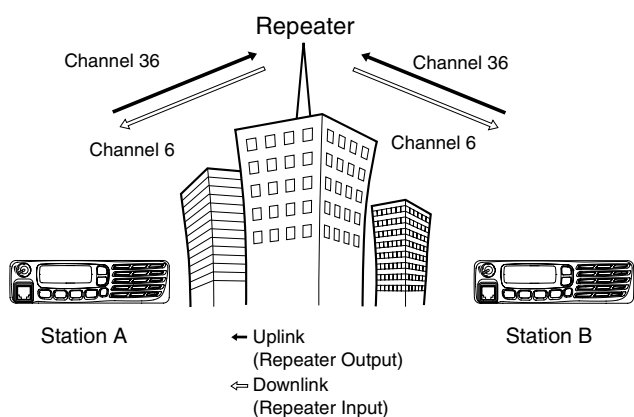

Section 5 SCAN

Scan types	5-2
Scanning	5-3
◇ Open scan.....	5-3
◇ Group scan/Priority scan.....	5-3
◇ Repeater scan.....	5-3

Scan types

The transceiver has 4 scan types to search for signals, Tag function and 4 Resume options, for scanning versatility.

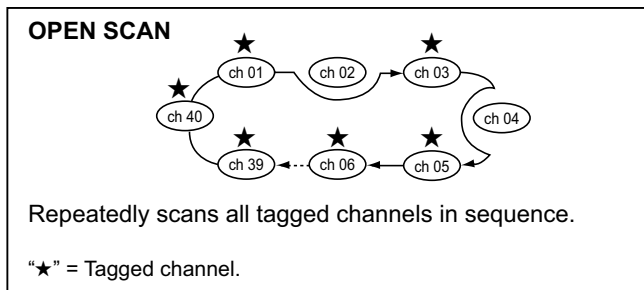

An Open scan automatically searches for busy channels and enables you to locate new stations for communication or listening.

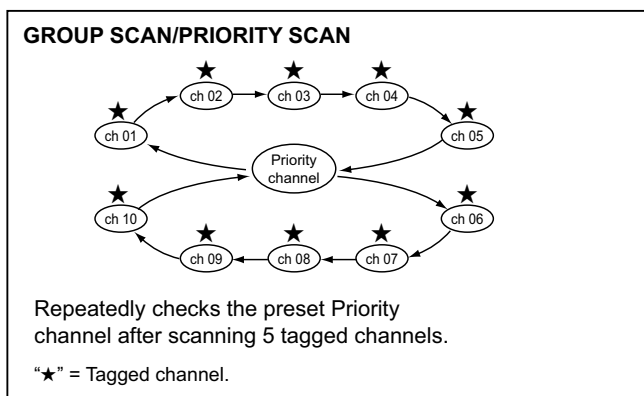

Group scan and Priority scan repeatedly searches for a signal on the Priority channel while scanning the tagged channels. This is useful when waiting for a call on the Priority channel or several tagged channels. Group and Priority scans are performed differently while transmitting. Group scan transmits on a Priority channel or on a busy channel, and Priority scan transmits only on the Priority channel. Tagged channels are independently set for Open, Group and Priority scans. All channels may be preset as tagged channels for all scans.

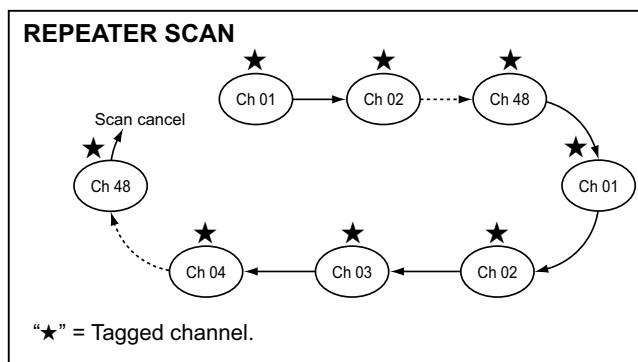

Scans all repeater channels (01 to 08 and 41 to 48)* in sequence. If there are no busy channels after scanning channels 01 to 08 and 41 to 48,* the scan begins from 01 again, and then the transceiver transmits a signal to search for a repeater while scanning.

* Excludes emergency repeater 05.

• Repeater scan flow

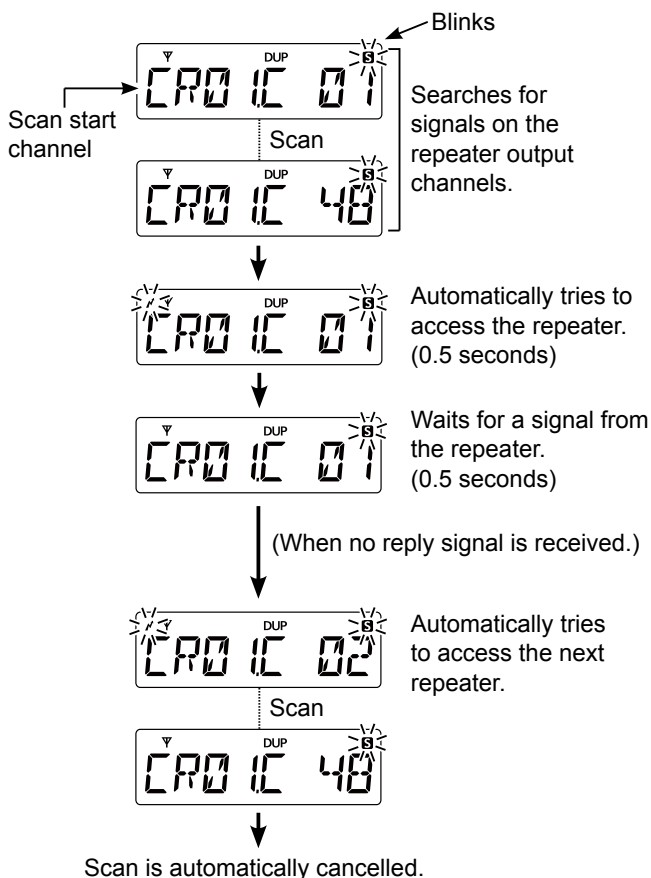

NOTE: Scan excludes the emergency repeater channel 05.

Scanning

The IC-410PRO scans all tagged channels when a scan is activated. When it detects a busy channel, the scan can be set to pause, or to resume after a pause. (Except for a Repeater scan).
See page 3-4 for details on the Scan Restart function.

1. Selecting a Scan mode

- 1) Enter the Set mode.
 - Hold down [FUNC] for 2 seconds.
- 2) Select "SCAN-M" menu.
 - Push [FUNC] until the "SCAN-M" menu is displayed.
- 3) Select a Scan mode.
 - Push [UP]/[DOWN].
- 4) Exit the Set mode.
 - Hold down [FUNC] for 2 seconds.

2. Setting a Tag channel

NOTE: All channels for each scan type are tagged by default. To select the channels to scan, you must first untag the undesired channels.

- 1) Select an undesired channel.
 - Push [UP]/[DOWN].
- 2) Untag the selected channel.
 - Hold down [SCAN] for 2 seconds.
 - "S" disappears when the tag setting is OFF.
- 3) Repeat step 1) and 2) until all the undesired channels are untagged.

To tag

- 1) Select the untagged channel.
 - Push [UP]/[DOWN].
- 2) Tag the selected channel.
 - Hold down [SCAN] for 2 seconds.
 - "S" is displayed when the selected channel is tagged.

3. Setting the Scan Stop Timer

Set the Scan Stop Timer in the Set mode.
See page 3-4 for details.

◇ Open scan

- 1) Start the scan.
 - Push [SCAN].
 - "S" blinks.
 - When receiving a signal, the scan pauses and then resumes according to the Scan Stop Timer setting.
- 2) Stop the scan.
 - Push [SCAN].

◇ Group scan/Priority scan

NOTE for Priority scan:

Set the priority channel before scanning.

- 1) Selecting the desired channel.
 - Push [UP]/[DOWN].
- 2) Turn ON the Function mode.
 - Push [FUNC].
 - "F" is displayed.
- 3) Set the priority channel.
 - Hold down [DUP] for 2 seconds.

- 1) Start the scan.
 - Push [SCAN].
 - "S" blinks.
 - When receiving a signal, the scan pauses and then resumes according to the Scan Stop Timer setting.
- 2) Stop the scan.
 - Push [SCAN].

◇ Repeater scan

- 1) Start the scan.
 - Push [SCAN].
 - "S" blinks.
 - When a signal is received on a repeater channel, the scan stops.
 - 3 high beeps sound when a signal is received while the transceiver trying to access the repeater.
 - 3 low beeps sound when no signal is received while the transceiver trying to access the repeater.
- 2) Stop the scan.
 - Push [SCAN].

Section 6

TONE SQUELCH AND POCKET BEEP

Tone Squelch	6-2
◇ Setting the CTCSS tone frequency/DTCS code	6-2
◇ Turning ON the Tone Squelch.....	6-2
Pocket Beep	6-3
◇ Waiting for a call from a station.....	6-3

Tone Squelch

The transceiver is equipped with 51 CTCSS (subaudible) tone frequencies, and 104 DTCS codes. CTCSS/DTCS operation enables you to communicate in the silent standby mode, since you will only receive calls from group members using the same CTCSS tone frequency or DTCS code.

NOTE: CTCSS/DTCS function is not selectable on CB channel 5, 35, and Repeater channel 5.

Information

The transceiver has 51 tone frequencies and consequently their spacing is narrow compared to units having 38 tones. Therefore, some tone frequencies may receive interference from adjacent tone frequencies.

◆ **Setting the CTCSS tone frequency/DTCS code**

- 1) Enter the Set mode.
 - ➔ Hold down [FUNC] for 2 seconds.
- 2) Select the CTCSS/DTCS menu.
 - ➔ Push [FUNC].
 - Selected CTCSS or DTCS code is displayed.
 - Push [MONI] to select between CTCSS and DTCS to enter the Setting mode.

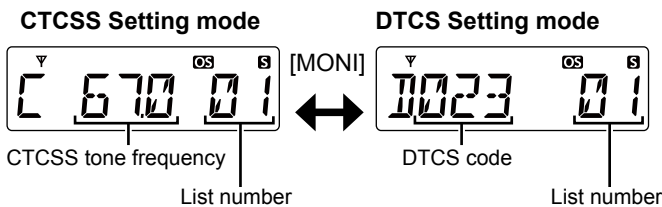

- 3) Set the desired CTCSS tone frequency or DTCS code.
 - ➔ Push [UP]/[DOWN].
- 4) Exit the Set mode.
 - ➔ Hold down [FUNC] for 2 seconds.

Selectable CTCSS tone frequency list (Hz)

No.	Freq.	No.	Freq.	No.	Freq.	No.	Freq.	No.	Freq.
01	67.0	12	94.8	23	136.5	34	177.3	45	218.1
02	69.3	13	97.4	24	141.3	35	179.9	46	225.7
03	71.0	14	100.0	25	146.2	36	183.5	47	229.1
04	71.9	15	103.5	26	151.4	37	186.2	48	233.6
05	74.4	16	107.2	27	156.7	38	189.9	49	241.8
06	77.0	17	110.9	28	159.8	39	192.8	50	250.3
07	79.7	18	114.8	29	162.2	40	196.6	51	254.1
08	82.5	19	118.8	30	165.5	41	199.5		
09	85.4	20	123.0	31	167.9	42	203.5		
10	88.5	21	127.3	32	171.3	43	206.5		
11	91.5	22	131.8	33	173.8	44	210.7		

Selectable DTCS code list

No.	Code	No.	Code	No.	Code	No.	Code	No.	Code
01	023	22	131	43	251	64	371	85	532
02	025	23	132	44	252	65	411	86	546
03	026	24	134	45	255	66	412	87	565
04	031	25	143	46	261	67	413	88	606
05	032	26	145	47	263	68	423	89	612
06	036	27	152	48	265	69	431	90	624
07	043	28	155	49	266	70	432	91	627
08	047	29	156	50	271	71	445	92	631
09	051	30	162	51	274	72	446	93	632
10	053	31	165	52	306	73	452	94	654
11	054	32	172	53	311	74	454	95	662
12	065	33	174	54	315	75	455	96	664
13	071	34	205	55	325	76	462	97	703
14	072	35	212	56	331	77	464	98	712
15	073	36	223	57	332	78	465	99	723
16	074	37	225	58	343	79	466	100	731
17	114	38	226	59	346	80	503	101	732
18	115	39	243	60	351	81	506	102	734
19	116	40	244	61	356	82	516	103	743
20	122	41	245	62	364	83	523	104	754
21	125	42	246	63	365	84	526		

◆ **Turning ON the Tone Squelch**

Before turning ON the Tone Squelch, set the desired CTCSS tone frequency or DTCS code in the Set mode.



- ➔ Hold down [MONI] for 2 seconds to turn ON the Tone Squelch.
 - Holding down [MONI] for 2 seconds switches between “TSQL” (Tone Squelch), “TSQL ” (Pocket Beep) and OFF (cancel).

Pocket Beep

This function uses the CTCSS tone and the DTCS code for calling. You can also use it as a “common pager” to inform you that someone called while you were away from the transceiver.

◇ **Waiting for a call from a station**

Before using the Pocket Beep, set the desired CTCSS tone frequency or DTCS code in the Set mode.

- 1) Hold down [MONI] for 2 seconds several times until “TSQL ” is displayed.
 - Holding down [MONI] for 2 seconds switches between “TSQL” (Tone Squelch), “TSQL ” (Pocket Beep), and OFF (cancel).
- 2) When you receive a signal with a matching tone or code, a beep sounds every 10 seconds and “” blinks.
- 3) Hold down [PTT] to answer and to stop the beep and blinking.
 - The transceiver automatically selects Tone Squelch.

Section 7 SELCALL (Selective Calling)

Description.....	7-2
Calling.....	7-2
◇ Selecting a TX code.....	7-2
◇ Editing the TX code.....	7-3
◇ Transmitting an individual Selcall.....	7-3
Receiving.....	7-4
◇ Receiving an individual Selcall.....	7-4
◇ Receiving a Group call.....	7-4
Quiet mode.....	7-4
Stun function	7-4

Description

Besides the Tone Squelch function for silent standby, you can use the Selcall (Selective Calling) function. Selcall has 100,000 options when using 5 tone. You can use the Selcall function to call another unit or call a Group on the same channel, as well as station code, text, the answer back function and auto scan start. These, and many more, can be set using the optional CS-410PRO CLONING SOFTWARE.

NOTE:

- Selcall cannot be used on CB channel 5, 35, and Repeater channel 5.
- A Selcall transmission is restricted to a total of 3 seconds in a 1 minute period.

Calling

TX code is the Selcall code that you transmit. You can enter maximum of 32 TX codes into the IC-410PRO, using the optional CS-410PRO CLONING SOFTWARE.

◇ Selecting a TX code

- 1) Select the desired CB channel or Repeater channel, except for CB channel 5, 35, and Repeater channel 5.
 - ➔ Push [UP]/[DOWN].
- 2) Turn ON the Function mode.
 - ➔ Push [FUNC].
 - "F" is displayed.
- 3) Enter the TX code selection mode.
 - ➔ Push [SCAN].

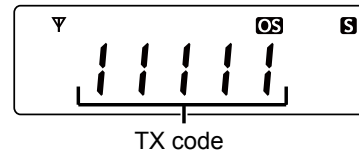

- If entered using the CS-410PRO CLONING SOFTWARE, the text is displayed instead of the code.

- 4) Select the desired TX code or text.
 - ➔ Push [UP]/[DOWN].
- 5) Push [PTT] to transmit the selected TX code, or push [SCAN] to set the selected TX code and exit the TX code selection mode.
 - When you transmit, a short beep sounds.

Information

You can assign TX code texts to all 32 TX codes using the CS-410PRO CLONING SOFTWARE.

Calling (Continued)

◇ **Editing the TX code**

You can edit the TX code within the allowed digits. The Group call function enables you to edit a special “Group code” of the Selcall ID code.

- 1) Select the desired CB channel or Repeater channel, except for CB channel 5, 35, and Repeater channel 5.
 - ➔ Push [UP]/[DOWN].
- 2) Turn ON the Function mode.
 - ➔ Push [FUNC].
 - “F” is displayed.
- 3) Enter the TX Code Selection mode.
 - ➔ Push [SCAN].
- 4) Enter the TX Code Editing mode.
 - ➔ Hold down [SCAN] for 2 seconds.
 - The editing digit blinks.

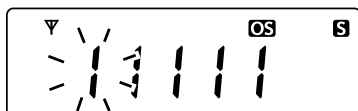

- 5) Edit the TX code.
 - ➔ Push [UP]/[DOWN].
- 6) Go to next digit.
 - ➔ Push [SCAN].

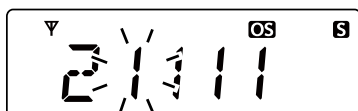

- 7) Repeat step 5) and 6) to enter all digits.
- 8) Exit the TX Code Editing mode.
 - ➔ Push [SCAN].
 - The editing digit stops blinking.
- 9) Push [PTT] to transmit the selected TX code, or push [SCAN] to set the selected TX code and exit the TX Code Selection mode.
 - When you transmit, a short beep sounds.

NOTE: The TX code digits that can be edited by the user are set using the CS-410PRO CLONING SOFTWARE.

◇ **Transmitting an individual Selcall**

- 1) Turn ON the Function mode.
 - ➔ Push [FUNC].
 - “F” is displayed.
- 2) Enter the TX Code Selection mode.
 - ➔ Push [SCAN].
- 3) Select the desired TX code.
 - ➔ Push [UP]/[DOWN].
- 4) Transmit an individual call.
 - ➔ Push [PTT].
 - A short beep sounds.

TIP: If you have already selected the TX code, you can transmit an individual Selcall as shown below.

- 1) Turn ON the Function mode.
 - ➔ Push [FUNC].
 - “F” is displayed.
- 2) Transmit an individual call.
 - ➔ Hold down [SCAN] for 2 seconds.
 - A short beep sounds.

Receiving

◇ Receiving an individual Selcall

When receiving an RX code:

- Beeps sound.
- The RX code's text is displayed, if entered.
- “🔔” and channel name blink, and the Selcall mute is released.
 - ➔ Hold down [PTT] and speak at your normal voice level.

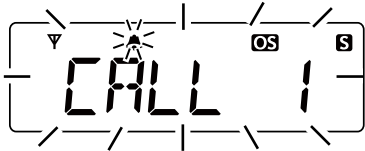

NOTE:

- If the ID decode function “ID Dec” is turned ON, the received Own ID code is displayed instead of the text, and stored into the transceiver. This function can be turned ON using the CS-410PRO CLONING SOFTWARE.
- A maximum of 8 individual RX codes can be stored into the transceiver.

◇ Receiving a Group call

When receiving a Group call:

- Beeps sound.
- “🔔” and “GROUP” blink, and the Selcall mute is released.
 - ➔ Hold down [PTT] and speak at your normal voice level.



- You can set the Group call receiving options using the optional CS-410PRO CLONING SOFTWARE. Consult the CS-410PRO help file for more information.

Quiet mode

When the Quiet mode is ON, the Selcall mute function is activated and enables silent operation until a Selcall code is received.

- 1) Enter the Set mode.
 - ➔ Hold down [FUNC] for 2 seconds.
- 2) Select the “QUIET” menu.
 - ➔ Push [FUNC].
- 3) Turn the Quiet mode ON or OFF.
 - ➔ Push [UP]/[DOWN].
 - “Q” is displayed when the Quiet mode is ON.
- 4) Exit the Set mode.
 - ➔ Hold down [FUNC] for 2 seconds.

NOTE: The Unmute mode may automatically return to the Mute mode after a specified time period, depending on the presetting.

Stun function

If the transceiver is in the Stun mode, it will request a password when you turn ON the transceiver. This function can only be set by your dealer. Once the password has been entered, the transceiver will not prompt you to enter it again.

Cloning and transceiver operations are disabled after a Kill ID is received. By activating the Clone Write mode, you can use the transceiver again. (The internal data cannot be accessed using the Clone Read mode.)

Smart Ring and ATS (Automatic Transponder System).....	8-2
◇ Smart Ring.....	8-2
◇ ATS	8-2
RX channels and frequencies	8-3
◇ Editing an RX frequency	8-3
Data cloning.....	8-3

Smart Ring and ATS (Automatic Transponder System)

Smart ring is the function to search for transceivers to receive or transmit in the group using the same CTCSS tone frequency.

ATS (Automatic Transponder System) is the function to automatically search for transceivers or repeaters to receive or transmit. When a call is received, the called station automatically sends an answer back signal even if the user is temporarily away from the transceiver.

◇ Smart Ring

- 1) Set the same CTCSS tone frequency to all the transceivers in the group. (p. 6-2)
- 2) Turn ON the Tone Squelch. (p. 6-2)
- 3) Turn ON the Function mode.
 - ➔ Push [FUNC].
 - “F” is displayed.
- 4) Send a Smart Ring call.
 - ➔ Hold down [MONI] for 2 seconds.
 - When a member of the group answers the call, “🔔” and “FOUND” blink.
 - If no answer is received, the transceiver sounds short failure beeps and “FAILED” appears.



- 5) Answer the call, and stop the blinking and the beeps.
 - ➔ Push [PTT].

NOTE:

- You can use the Smart Ring function only if the called station has the same CTCSS tone frequency and is operating on the same channel.
- The setting above is for only the calling station. A called station automatically sends an answer back signal without any presetting. All the IC-410PROs set to the same operating channel within the communication area will send an answer back call.

◇ ATS

- 1) Turn ON the Function mode.
 - ➔ Push [FUNC].
 - “F” is displayed.
- 2) Turn ON the ATS function.
 - ➔ Push [MONI].
 - When an RX channel is selected, an error beep sounds.
 - The transceiver automatically sends a searching signal every 60 seconds.
 - “▽” blinks.
 - The transceiver or repeater receives the ATS signal will automatically send an answer back signal.
 - When you receive the answer back signal, “▽” stops blinking until the next search transmission.
 - If no reply is received, “▽” blinks until the next search transmission.

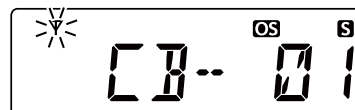

- 3) Turn OFF the ATS function.
 - ➔ Push [FUNC], and then [MONI] again.

RX channels and frequencies

You can enable the use of the RX channels on the transceiver screen using the optional CS-410PRO CLONING SOFTWARE. RX channels are not displayed as the default.

Also, you can edit the RX frequencies between 450 through 520 MHz using the CS-410PRO or using the transceiver if the RX channels have been enabled.

◇ Editing an RX frequency

- 1) Select the desired RX channel (Example: RX-01).
- 2) Enter the Set mode.
 - ➔ Hold down [FUNC] for 2 seconds.
- 3) Select "RX VFO" menu.
 - ➔ Push [FUNC].
- 4) Enter the RX VFO mode.
 - ➔ Push [UP]/[DOWN].
 - RX frequency is displayed.
 - Push [SCAN] to set the channel spacing to between wide and narrow.
- 5) Select the desired RX frequency. The frequency selection scrolls according to the channel spacing selected in step 4).
 - ➔ Push [UP]/[DOWN].

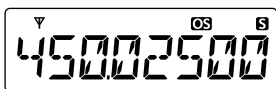

Wide channel spacing
(25 kHz steps)

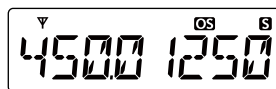

Narrow channel spacing
(12.5 kHz steps)

- 6) Select the editing digit.
 - ➔ Push [FUNC].
 - The editing digit blinks.



- 7) Set the desired number to the digit.
 - ➔ Push [UP]/[DOWN].
- 8) Go to next digit.
 - ➔ Push [FUNC].



- 9) Repeat step 7) and 8) to edit the RX frequency.
- 10) Finish editing digit.
 - ➔ Push [FUNC].
 - The editing digit stops blinking.
- 11) Return to the Standby mode.
 - ➔ Push [DUP], and then hold down [FUNC] for 2 seconds.

Data cloning

Data cloning enables you to transfer data quickly and easily from a PC to a transceiver, using the optional CS-410PRO CLONING SOFTWARE.

You can clone the data to or from a PC, using the optional OPC-1122U CLONING CABLE.

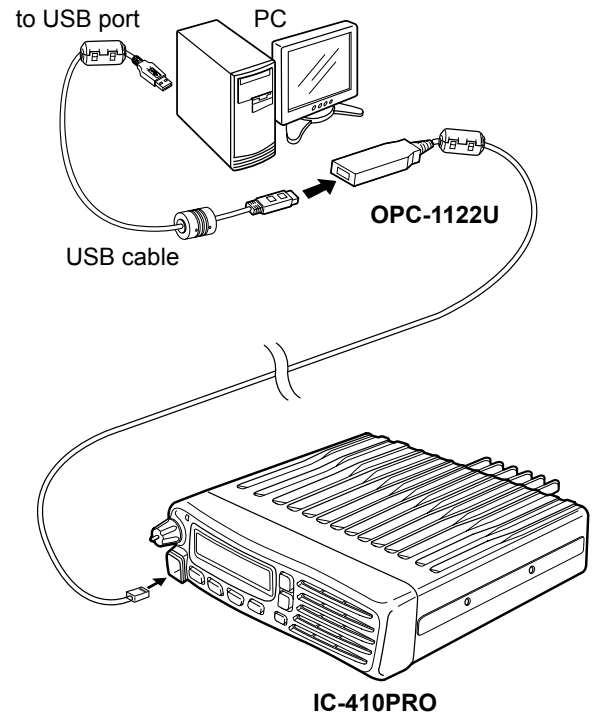

Section 9

SPECIFICATIONS

SPECIFICATIONS.....	9-2
◇ General	9-2
◇ Transmitter.....	9-2
◇ Receiver.....	9-2

Specifications

◇ General

- Frequency coverage:
 - CB 476.4250–477.4125 MHz
 - RX/Private 450.0000–520.0000 MHz
- Type of emission:
 - CB 8K50F3E
 - RX/Private 8K50F3E/16K0F3E
- Channel spacing:
 - CB 12.5 kHz
 - RX/Private 12.5/25 kHz
- Current drain (at 13.8 V):
 - TX (at 5 W) approximately 4.0 A
 - TX (at 25 W) approximately 7.0 A
 - Max. audio approximately 1200 mA
- Operating temperature range: –30°C to +60°C
- Power supply requirement: 13.8 V DC nominal (Negative ground)
- Frequency stability: ±2.5 ppm (–30°C to + 60°C)
- Antenna impedance: 50 Ω nominal
- Dimensions: W 150 × H 40 × D 117.5 mm (Projections not included)
- Weight: approximately 800 g

◇ Transmitter

- Output power:
 - CB 5 W/1 W
 - Private 25 W/5 W/1 W
- Modulation system: Variable reactance frequency modulation
- Max. frequency deviation:
 - Narrow ±2.5 kHz
 - Wide ±5.0 kHz
- Spurious emissions: –30 dBm (maximum)

◇ Receiver

- Sensitivity (12 dB SINAD): 0.25 μV (typical)
- Squelch sensitivity: 0.25 μV (typical)
- Intermodulation rejection ratio: 75 dB (typical)
- Spurious response rejection ratio: 70 dB (minimum)
- Audio output power: 4.0 W (typical) at 5% distortion into a 4 Ω load

All stated specifications are subject to change without notice or obligation.

INDEX

A		P	
ATS (Automatic Transponder System)	8-2	Pocket Beep	6-3
Auto Power OFF	3-4	Power ON password	2-2
B		Priority channel	2-3
Backlight	3-3	Priority channel, cancelling	2-3
Battery Voltage	3-4	Priority channel, selecting	2-3
Beep	3-3	Priority channel, setting	2-3
Beep Level.....	3-3	Q	
C		Quiet mode	3-4, 7-4
Call from a station	6-3	R	
Channel selection.....	2-2	Receiving, Selcall.....	7-4
CTCSS	6-2	Repeater, accessing	4-2
CTCSS tone frequency list	6-2	Repeater operation	4-2
CTCSS tone frequency, setting	6-2	RF Power	3-3
D		Roger beep	3-4
Data cloning	8-3	RX VFO	3-4
DTCS	6-2	S	
DTCS code list	6-2	Scan, group	5-2, 5-3
DTCS code, setting	6-2	Scan mode	3-3
G		Scan, open	5-2, 5-3
Group call, receiving	7-4	Scan, priority	5-2, 5-3
H		Scan, repeater	5-2, 5-3
Horn	3-4	Scan Restart	3-4
I		Scan Stop Timer	3-4
Individual Selcall, receiving.....	7-4	Scan types.....	5-2
Individual Selcall, transmitting	7-3	Set mode sequence	3-2
K		Signal Monitor	3-4
Keylock	2-2	Smart Ring.....	8-2
Keys, non-locked	2-2	Specifications	9-2
L		Squelch	2-3
Lockout	3-4	Squelch Level	3-3
M		Stun function	7-4
Mic Gain.....	3-5	T	
Monitor	2-3	Tag channel, setting.....	5-3
O		Tone Squelch	6-2
Own ID	3-5	Z	
		Zone selection	2-2

Count on us!

